

PLAN 1 1/2" = 1'-0"

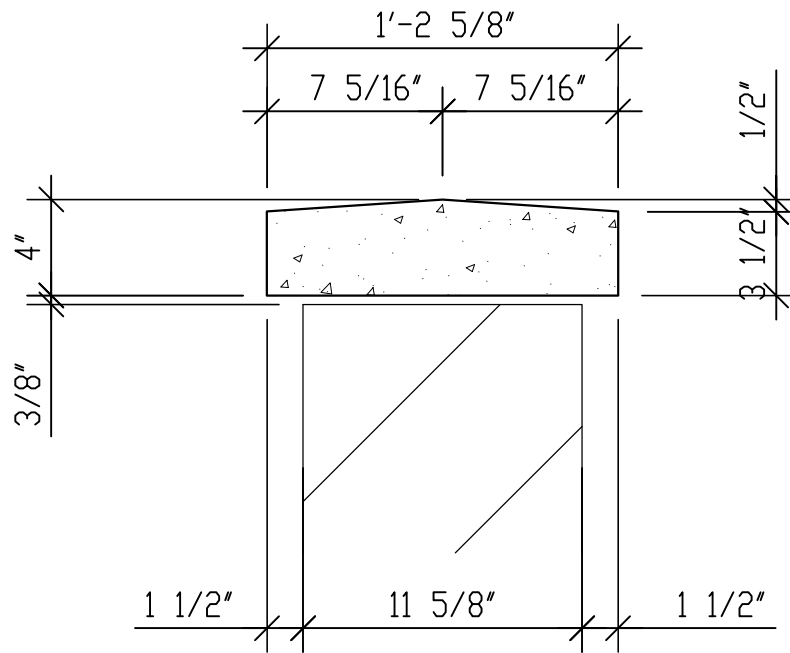

SECTION 1 1/2" = 1'-0"

AnchorArt

Column Cap, 4" high, 12"sq. column

quantity

sample

70lbs.

CC 04 12