

PLAN 1 1/2" = 1'-0"

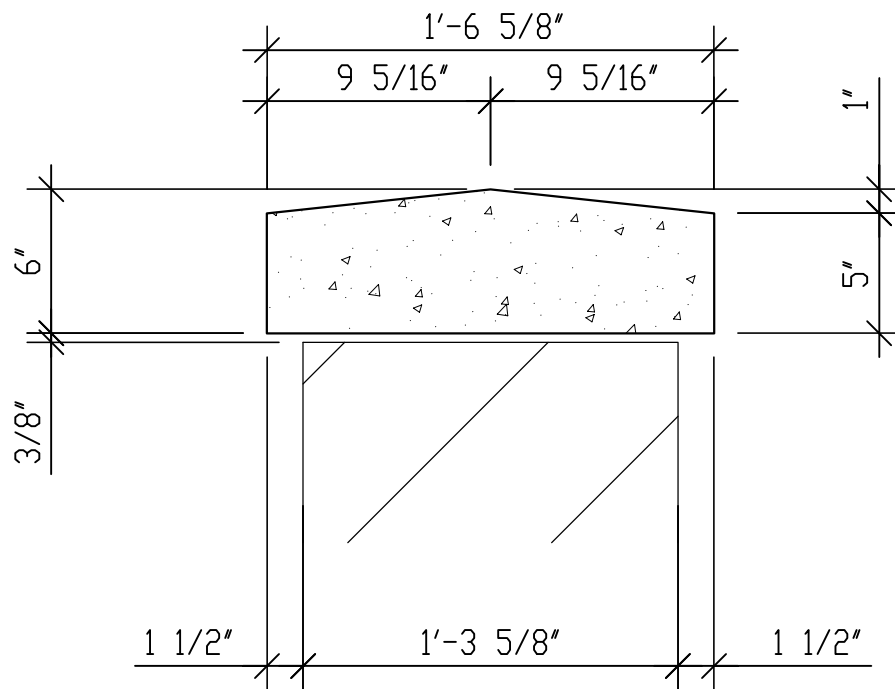

SECTION 1 1/2" = 1'-0"

AnchorArt

Column Cap, 6" high, 16"sq. column

quantity

sample

150lbs.

CC 06 16