

PLAN 1 1/2" = 1'-0"

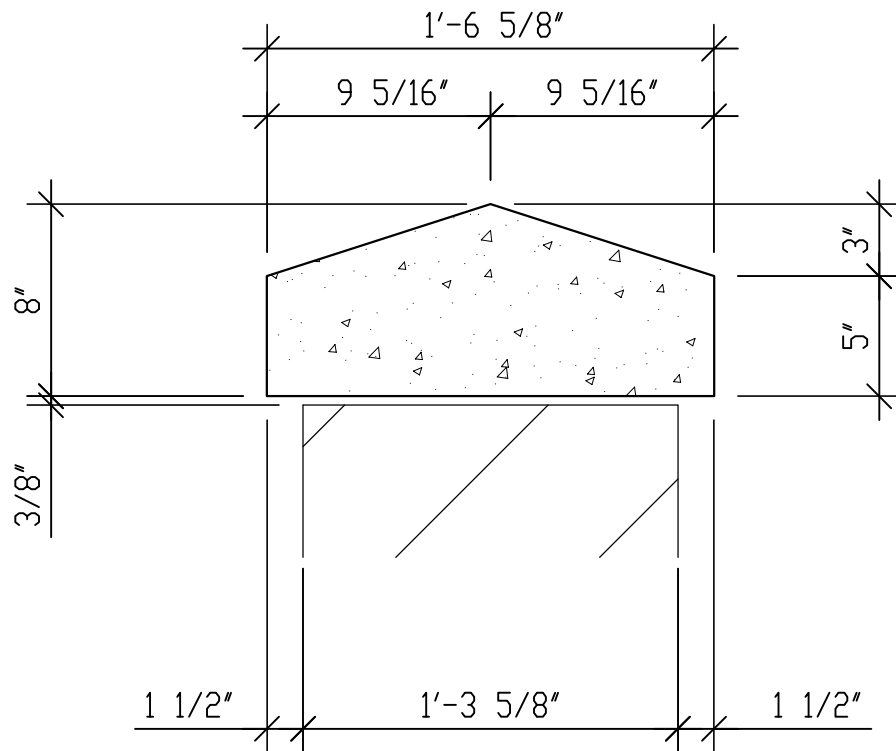

SECTION 1 1/2" = 1'-0"

AnchorArt

Column Cap, 8" high, 16"sq. column

quantity

sample

196lbs.

CC 08 16