

PLAN

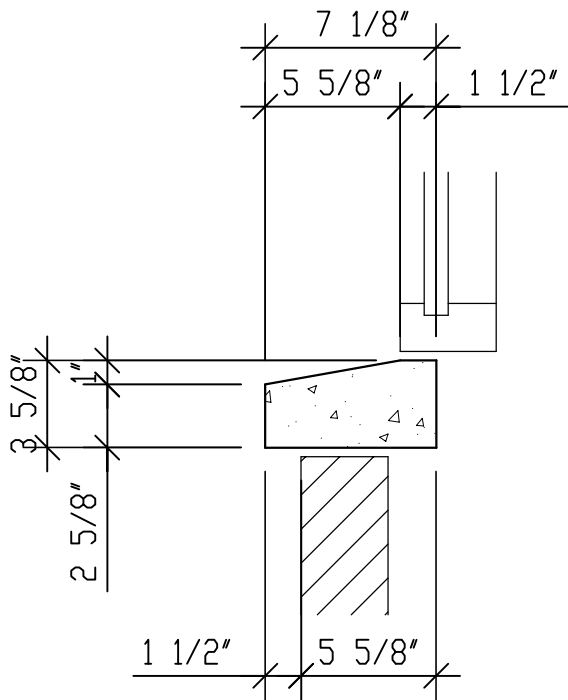

SECTION

AnchorArt

Slip sill, 4" high, 6" dp, 48" m.o.

quantity

sample

96lbs.

SS040648