

PLAN

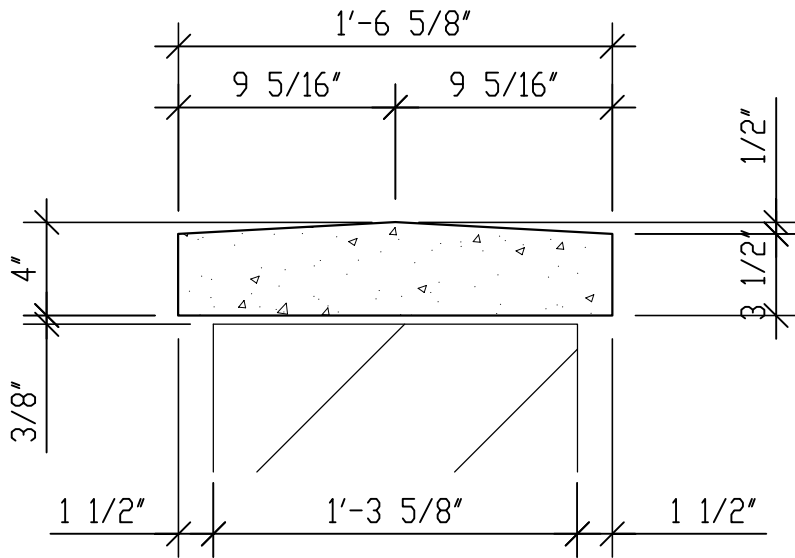

SECTION 1

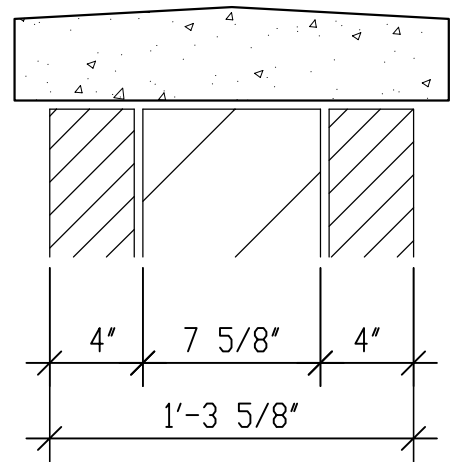

SECTION 2

AnchorArt

Wall cap, 4" high, 16" wall, straight

quantity

sample

290lbs.

WC 04 16S