

PLAN

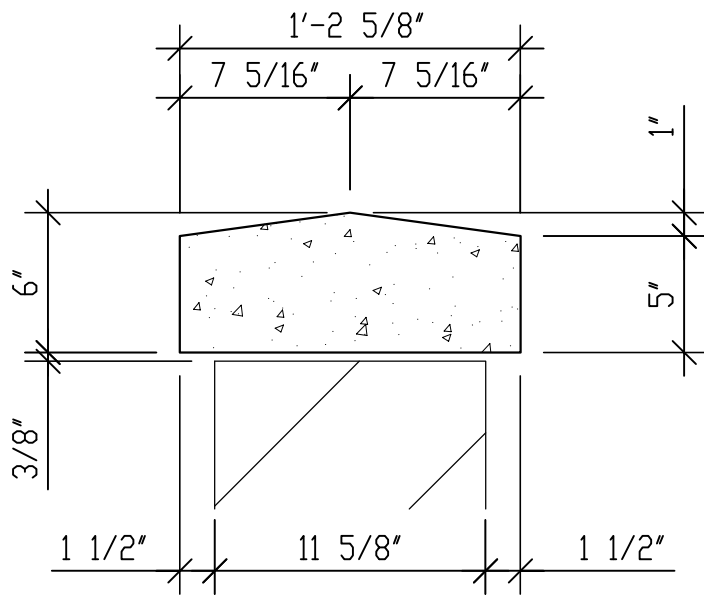

SECTION 1

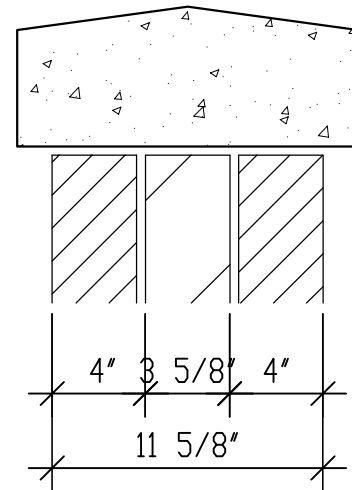

SECTION 2

AnchorArt

Wall cap, 6" high, 12" wall, finished end

quantity

sample

333lbs.

WC 06 12F