

PLAN 1

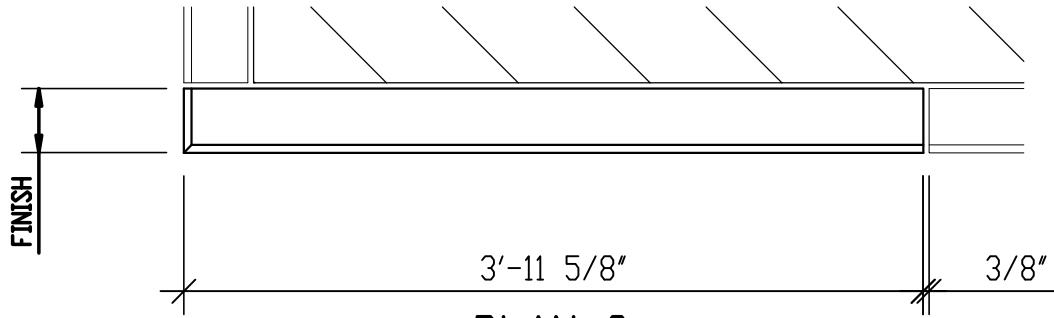

PLAN 2

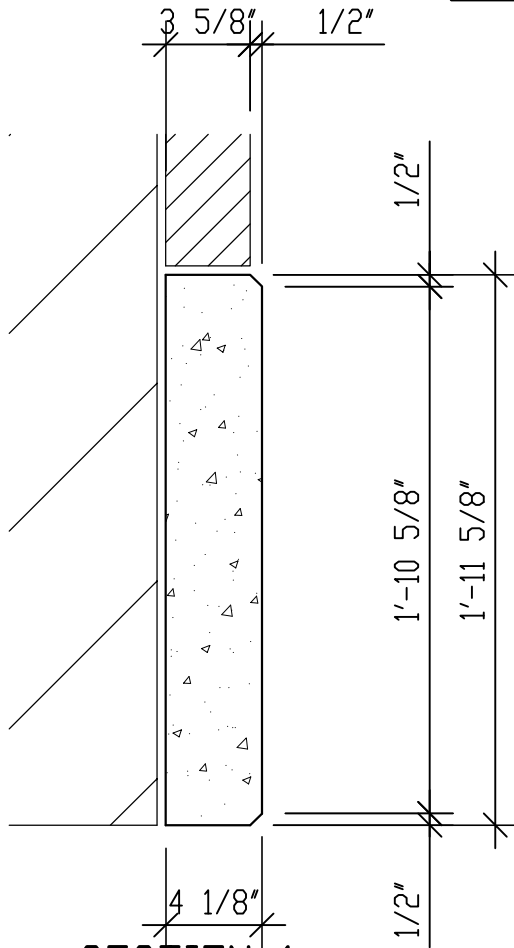

SECTION 1

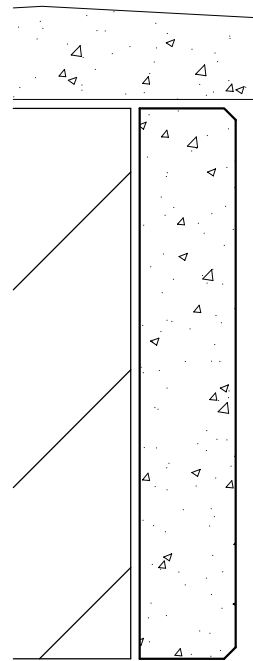

SECTION 2

**AnchorArt**

Wall panel, 24" high, 1/2" chamfer, return end

quantity

sample

400lbs.

WP24.5C R